



# GDE25S12B-E DC-DC Converter

## Technical Manual

Issue 1.0  
Date 2020-11-30

HUAWEI TECHNOLOGIES CO., LTD.



# About This Document

## Purpose

This document describes the GDE25S12B-E DC-DC converter, including its electrical specifications, features and applications.

The figures provided in this document are for reference only.





## Intended Audience

This document is intended for:

- Sales personnel
- Technical support engineers
- System engineers
- Software engineers
- Hardware engineers

## Symbol Conventions

The symbols that may be found in this document are defined as follows.

Symbol	Description
 <b>DANGER</b>	Indicates a hazard with a high level of risk which, if not avoided, will result in death or serious injury.
 <b>WARNING</b>	Indicates a hazard with a medium level of risk which, if not avoided, could result in death or serious injury.
 <b>CAUTION</b>	Indicates a hazard with a low level of risk which, if not avoided, could result in minor or moderate injury.
<b>NOTICE</b>	Indicates a potentially hazardous situation which, if not avoided, could result in equipment damage, data loss, performance deterioration, or unanticipated results. NOTICE is used to address practices not related to personal injury.
 <b>NOTE</b>	Supplements the important information in the main text. NOTE is used to address information not related to personal injury, equipment damage, and environment deterioration.

## Change History

Changes between document issues are cumulative. The latest document issue contains all the changes made in earlier issues.

### **Issue 1.0 (2020-11-30)**

This issue is the first release.

# Contents

<b>About This Document.....</b>	<b>i</b>
<b>1 Product Overview.....</b>	<b>1</b>
<b>2 Electrical Specifications.....</b>	<b>2</b>
2.1 Absolute Maximum Ratings.....	2
2.2 Input.....	2
2.3 Output.....	3
2.4 Efficiency.....	5
2.5 Protection.....	5
2.6 Dynamic Characteristics.....	6
2.7 Insulation Characteristics.....	7
<b>3 Characteristic Curves.....</b>	<b>8</b>
<b>4 Typical Waveforms.....</b>	<b>9</b>
4.1 Power-On/Power-Off.....	9
4.2 Output Voltage Dynamic Response.....	10
4.3 Input/Output Ripple.....	11
4.4 Output Voltage Rise Time.....	11
<b>5 Remote On/Off.....</b>	<b>12</b>
<b>6 Protection Characteristics.....</b>	<b>13</b>
<b>7 Mechanical Overview.....</b>	<b>14</b>
<b>8 Safety.....</b>	<b>16</b>
8.1 Reliability Characteristics.....	16
8.2 EMC Specifications.....	16
8.3 Recommended Fuse.....	17
8.4 Recommended Reverse Polarity Protection Circuit.....	17
8.5 Qualification Testing.....	18
8.6 Thermal Consideration.....	18
8.7 MSL Rating.....	19
8.8 Mechanical Consideration.....	19

# 1 Product Overview

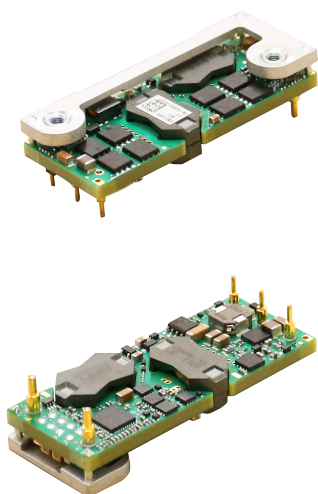

## Product Description

The GDE25S12B-E is isolated DC-DC converters that use an industry standard eighth-brick structure and feature high efficiency and power density with low output ripple and noise. It operates from an input voltage range of 36 V to 75 V, and provide the rated output voltage of 12 V as well as the maximum output current of 25 A.

## Model Naming Convention

GDE	25	S	12	B	-	E
1	2	3	4	5	-	6

1 — 48 V input, high performance, digital control eighth-brick

2 — Output current: 25 A

3 — Single output

4 — Output voltage: 12 V

5 — With a baseplate

6 — Version

## Features

- Efficiency: 94.2% ( $V_{in} = 48\text{ V}$ ,  $T_A = 25^\circ\text{C}$ , 100% load)
- Length x Width x Height: 58.4 mm x 22.9 mm x 12.1 mm (2.30 in. x 0.90 in. x 0.48 in.)
- Weight: about 32 g
- Input undervoltage protection, output overcurrent protection (Hiccup mode), output short-circuit protection (hiccup mode), output overvoltage protection (hiccup mode), overtemperature protection (automatic recovery)
- Remote On/Off
- CE, UL certification
- UL 60950-1, UL 62368-1, C22.2 No. 60950-1, EN 60950-1 and EN 62368-1 compliant
- RoHS6 compliant

## Applications

- Servers
- Telecom and data communication applications
- Industrial equipment

# 2 Electrical Specifications

## 2.1 Absolute Maximum Ratings

**Table 2-1** Environmental specification

Parameter	Minimum	Typical	Maximum	Unit	Notes & Conditions
Input voltage continuous	-	-	80	V	When the input voltage is 75 V to 80 V, the converter must not be damaged. Not all the characteristic parameters should be conformed to the specification.
Input voltage transient (100 ms)	-	-	100	V	-
External voltage applied to On/Off	-	-	12	V	-
Operating ambient temperature (T <sub>A</sub> )	-40	-	85	°C	-
Storage temperature	-55	-	125	°C	-
Operating humidity	10	-	95	% RH	Non-condensing
Altitude	-	-	5000	m	54 kPa

## 2.2 Input

**Table 2-2** Input specification

Parameter	Minimum	Typical	Maximum	Unit	Notes & Conditions
Operating input voltage	36	48	75	V	-

Parameter	Minimum	Typical	Maximum	Unit	Notes & Conditions
Maximum input current	-	-	9.5	A	$V_{in} = 0\text{ V to }75\text{ V}$ , $I_{out} = 25\text{ A}$
No-load loss	-	3.5	5.5	W	$V_{in} = 48\text{ V}$ , $I_{out} = 0\text{ A}$ , $T_A = 25^\circ\text{C}$
Remote on/off loss	-	-	2.5	W	$V_{in} = 48\text{ V}$ , $I_{out} = 0\text{ A}$ , $T_A = 25^\circ\text{C}$
Input capacitance	100	330	-	$\mu\text{F}$	Aluminum electrolytic capacitor
Response to input transient	-	1.5	2.0	V	Input transient: $0.5\text{ V}/\mu\text{s}$ $V_{in} = 42\text{ V to }75\text{ V}$ , 100% load
	-	-	3.0	V	Input transient: $0.5\text{ V}/\mu\text{s}$ $V_{in} = 36\text{ V to }75\text{ V}$ , 100% load

## 2.3 Output

Table 2-3 Output specification

Parameter	Minimum	Typical	Maximum	Unit	Notes & Conditions
Output voltage set point	11.88	12.00	12.12	V	$V_{in} = 48\text{ V}$ , $I_{out} = 12.5\text{ A}$
Output voltage range	11.64	-	12.36	V	$V_{in} = 42\text{ V to }75\text{ V}$ , $I_{out} = I_{omin} - I_{onom}$
	10.00	-	12.36	V	$V_{in} = 36\text{ V to }42\text{ V}$ , $I_{out} = I_{omin} - I_{onom}$
Output current	0	-	25	A	-
Output power	0	-	300	W	$V_{in} = 48\text{ V}$ , $V_{out} = 12\text{ V}$
Output line regulation	-0.5	-	0.5	% $V_{out}$	$V_{in} = 42\text{ V to }75\text{ V}$ ; $I_{out} = 25\text{ A}$
	-17	-	17	% $V_{out}$	$V_{in} = 36\text{ V to }42\text{ V}$ ; $I_{out} = 25\text{ A}$
Output load regulation	-4	-	4	% $V_{out}$	$V_{in} = 48\text{ V}$ ; $I_{out} = I_{omin} - I_{onom}$



Parameter	Minimum	Typical	Maximum	Unit	Notes & Conditions
Temperature coefficient	-0.02	-	0.02	%/°C	$T_A = -40^{\circ}\text{C}$ to $+85^{\circ}\text{C}$ ( $-40^{\circ}\text{F}$ to $+185^{\circ}\text{F}$ )
External capacitance	440	680	2500	$\mu\text{F}$	SMD aluminum solid capacitor $\geq 440 \mu\text{F}$ , and additional ceramic capacitor $\geq 20 \mu\text{F}$ . When the temperature is lower than $-5^{\circ}\text{C}$ , the type of the external capacitance should be SMD aluminum solid capacitor, and the value at least $1000 \mu\text{F}$ . The distance between the output capacitance and the output port pin is less than 3 cm.
Regulated voltage precision	-5	-	5	%	$V_{in} = 42 \text{ V}$ to $75 \text{ V}$ ; $I_{out} = I_{omin} - I_{onom}$
	-18	-	18	%	$V_{in} = 36 \text{ V}$ to $42 \text{ V}$ ; $I_{out} = I_{omin} - I_{onom}$
Output ripple and noise (peak to peak)	-	150	400	mV	Oscilloscope bandwidth: 20 MHz Ceramic chip capacitor $\geq 20 \mu\text{F}$
Output voltage overshoot	-	-	5	%	Full ranges of $V_{in}$ , $I_{out}$ , and $T_A$
Output voltage delay time	-	50	100	ms	From $V_{in}$ connection to 10% $V_{out}$
Output voltage rise time	-	50	100	ms	From 10% $V_{out}$ to 90% $V_{out}$
Turn off hold up time	100	-	-	$\mu\text{s}$	From 10% $V_{out}$ to 90% $V_{out}$ With minimum external capacitance, no load
Switching frequency	-	180	-	kHz	-



## 2.4 Efficiency

**Table 2-4** Efficiency

Parameter	Minimum	Typical	Maximum	Unit	Notes & Conditions
100% load	93.2	94.2	-	%	$V_{in} = 48\text{ V}$ ; $T_A = 25^\circ\text{C}$ ; $V_{out} = 12\text{ V}$
60% load	93.3	94.3	-	%	
50% load	93.5	93.5	-	%	
20% load	89.8	90.8	-	%	

## 2.5 Protection

**Table 2-5** Input protection

Parameter	Minimum	Typical	Maximum	Unit	Notes & Conditions
Input undervoltage protection startup threshold	32	34	36	V	-
Input undervoltage protection shutdown threshold	30	32	34	V	-
Input undervoltage protection hysteresis	1	2	3	V	-

**Table 2-6** Output protection

Parameter	Minimum	Typical	Maximum	Unit	Notes & Conditions
Output overcurrent protection	110	-	140	% $I_{omax}$	Hiccup mode
Output short circuit protection	-	-	-	-	Hiccup mode

Parameter	Minimum	Typical	Maximum	Unit	Notes & Conditions
Output overvoltage protection	13.2	-	16	V	Hiccup mode The continuous output voltage must be less than 15 V, the time must be less than 100 ms when the output voltage is between 15 V and 16 V.
Overtemperature protection threshold	105	115	130	°C	Automatic recovery The overtemperature protection hysteresis is obtained by measuring the temperature of the PCB near the temperature sensor.
Overtemperature protection hysteresis	5	-	-	°C	

## 2.6 Dynamic Characteristics

Table 2-7 Dynamic characteristics

Parameter	Minimum	Typical	Maximum	Unit	Notes & Conditions
Overshoot amplitude	-	-	600	mV	Current change rate: 0.1 A/μs, $V_{in} = 42\text{ V}$ to 75 V, load: 25%–50%–25%, 50%–75%–50%
Recovery time	-	-	200	μs	
Overshoot amplitude	-	-	600	mV	Current change rate: 1 A/μs, $V_{in} = 42\text{ V}$ to 75 V, load: 25%–50%–25%, 50%–75%–50% (Additional 1000 μF aluminum solid capacitor at output terminal)
Recovery time	-	-	300	μs	

## 2.7 Insulation Characteristics

**Table 2-8** Insulation characteristics

Parameter	Minimum	Typical	Maximum	Unit	Notes & Conditions
Input to output insulation voltage	-	-	1500	V	Functional insulation; leakage current < 1 mA; 1 min
Input to baseplate insulation voltage	-	-	750	V	
Output to baseplate insulation voltage	-	-	750	V	

# 3 Characteristic Curves

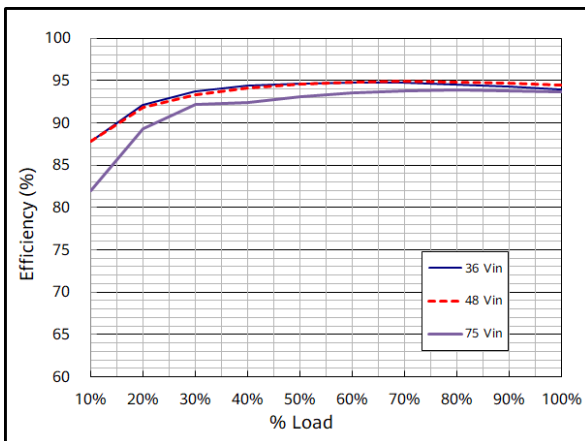

Efficiency curve

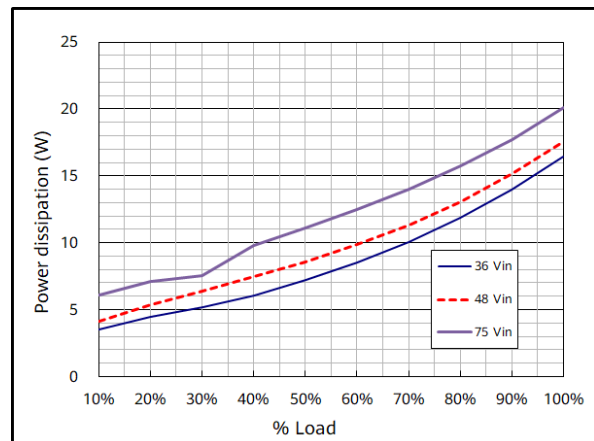

Power dissipation curve

# 4 Typical Waveforms

#### NOTE

- During the test of input reflected ripple current, the input terminal must be connected to the external input filter (include a 12  $\mu\text{H}$  inductor and a 220  $\mu\text{F}$  electrolytic capacitor), which is not required in other tests.
- Points B and C, which are for testing the output voltage ripple, are 25 mm (0.98 in.) away from the  $V_{\text{out}}$  (+) pin and the  $V_{\text{out}}$  (-) pin.

**Figure 4-1** Test setup diagram

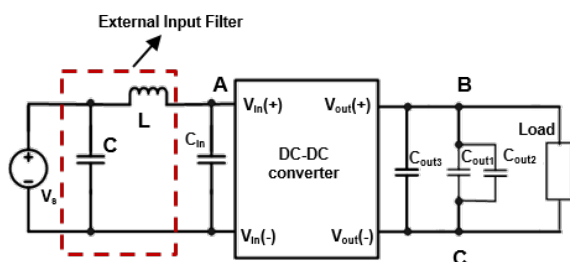

$C_{\text{in}}$ : The 100  $\mu\text{F}$  aluminum electrolytic capacitor is recommended.

$C_{\text{out1}}$ : The 0.1  $\mu\text{F}$  ceramic capacitor is recommended.

$C_{\text{out2}}$ : The 10  $\mu\text{F}$  electrolytic capacitor is recommended.

$C_{\text{out3}}$ : The 440  $\mu\text{F}$  SMD aluminum solid capacitor and additional ceramic capacitor 20  $\mu\text{F}$  is recommended.

**Figure 4-2** Typical application circuit

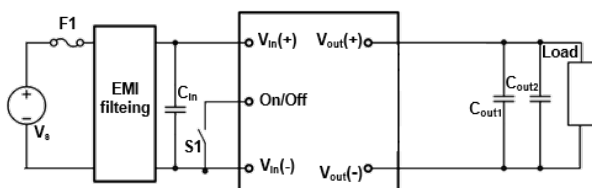

F1: 20 A fuse (fast blowing)

$C_{\text{in}}$ : The 100  $\mu\text{F}$  aluminum electrolytic capacitor is recommended.

$C_{\text{out1}}$ : The 1  $\mu\text{F}$  ceramic capacitor is recommended.

$C_{\text{out2}}$ : The 440  $\mu\text{F}$  SMD aluminum solid capacitor and additional ceramic capacitor 20  $\mu\text{F}$  is recommended.

## 4.1 Power-On/Power-Off

Conditions:  $T_A = 25^\circ\text{C}$ ,  $V_{\text{in}} = 48\text{ V}$ .

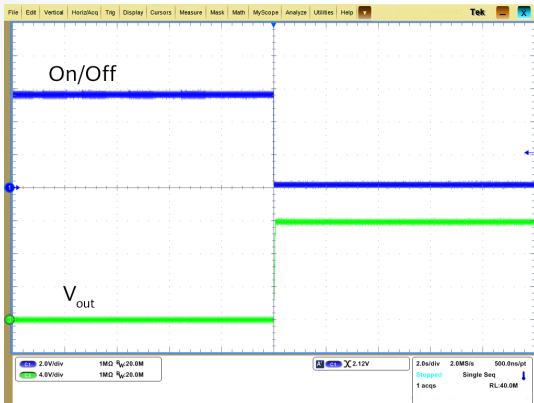

Startup from On/Off



Shutdown from On/Off

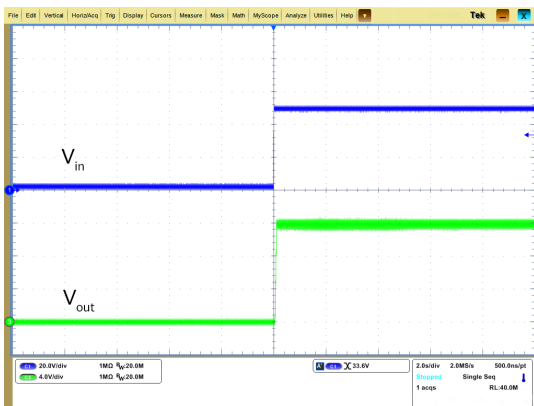

Startup by power on

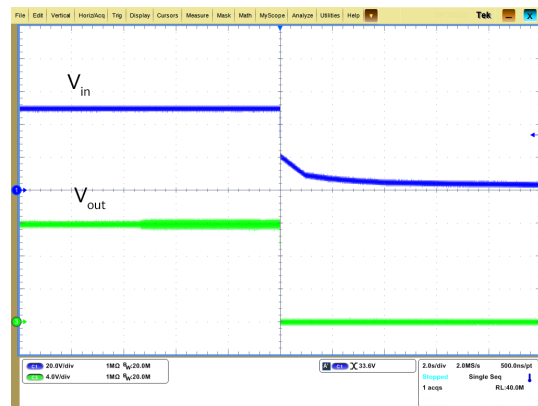

Shutdown by power off

## 4.2 Output Voltage Dynamic Response

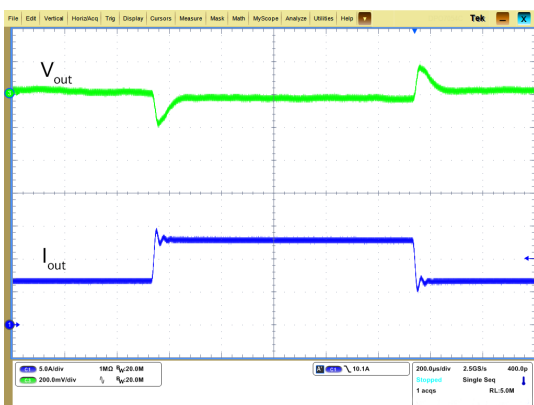

Output voltage dynamic response  
(Load: 25%–50%–25%,  $V_{in} = 42\text{--}75\text{ V}$ ,  $di/dt = 0.1\text{ A}/\mu\text{s}$ )

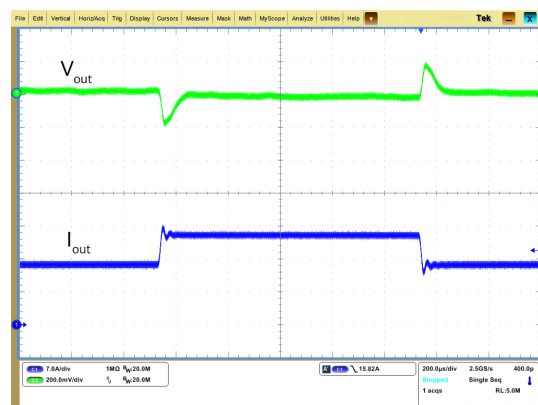

Output voltage dynamic response  
(Load: 50%–75%–50%,  $V_{in} = 42\text{--}75\text{ V}$ ,  $di/dt = 0.1\text{ A}/\mu\text{s}$ )

### 4.3 Input/Output Ripple

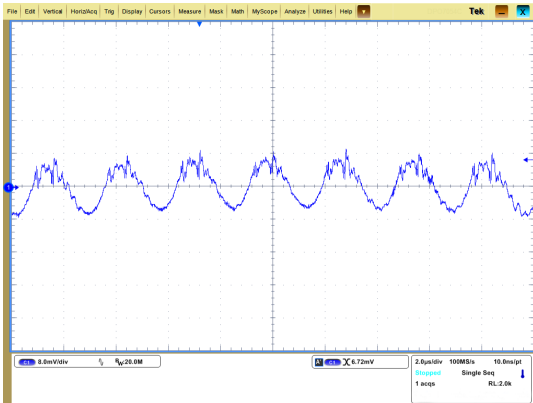

Output voltage ripple

(For point BC in the test set-up diagram,  $V_{in} = 48\text{ V}$ ,  $V_{out} = 12\text{ V}$ ,  $I_{out} = 25\text{ A}$ )

### 4.4 Output Voltage Rise Time

#### NOTE

- When the rising slope of  $V_{in}$  is below  $0.3\text{ V/ms}$ ,  $V_{out}$  rises to  $10\text{ V}$  within  $50\text{ ms}$  (typical) and then rises to terminal value at the rate of  $0.065\text{ V/s}$ .
- The typical time of  $[0, t_1]$  is  $50\text{ ms}$ , and typical time of  $[t_1, t_2]$  is  $34\text{ s}$ .

Figure 4-3 Output voltage rise time

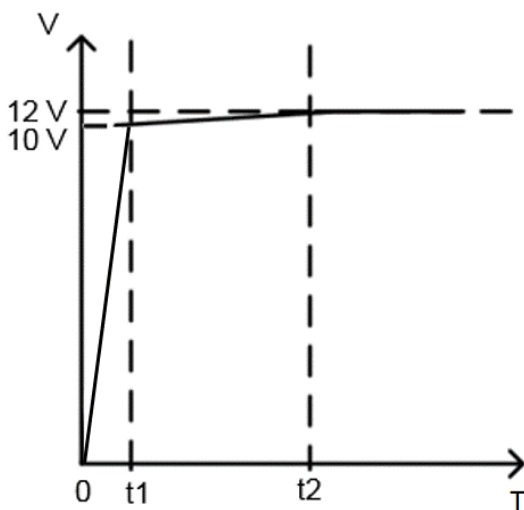



# 5 Remote On/Off

The main output of module can be turned on or turned off by the On/Off signal.

On/Off Pin Level	Status
Low level [-0.7 V, 1.2 V]	On
High level [3.5 V, 12.0 V]	Off

On/Off Signal	Maximum
On/Off current (low level)	1 mA

**Figure 5-1** Various circuits for driving the On/Off pin

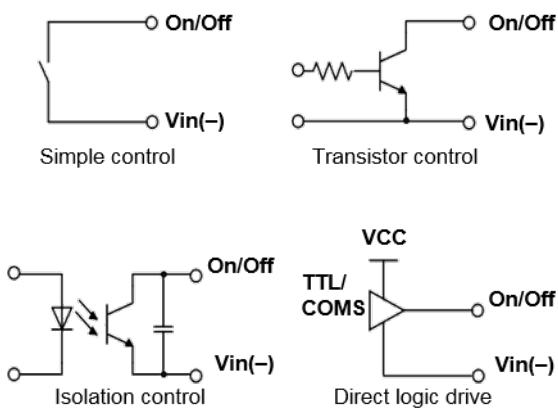

# 6 Protection Characteristics

---

- **Input Undervoltage Protection**

The converter will shut down after the input voltage drops below the undervoltage protection threshold. The converter will start to work again after the input voltage reaches the input undervoltage recovery threshold. For the hysteresis, see [2.5 Protection](#).

- **Output Overvoltage Protection**

When the output voltage exceeds the output overvoltage protection threshold, the converter will enter hiccup mode. When the fault condition is removed, the converter will automatically restart.

- **Output Overcurrent Protection**

The converter equipped with current limiting circuitry can provide protection from an output overload or short circuit condition. If the output current exceeds the output overcurrent protection setpoint, the converter enters hiccup mode. When the fault condition is removed, the converter will automatically restart.

- **Overtemperature Protection**

A temperature sensor on the converter senses the average temperature of the converter. It protects the converter from being damaged at high temperatures. When the temperature exceeds the overtemperature protection threshold, the output will shut down. It will allow the converter to turn on again when the temperature of the sensed location falls by the value of the overtemperature protection hysteresis.

# 7 Mechanical Overview

Figure 7-1 Mechanical overview

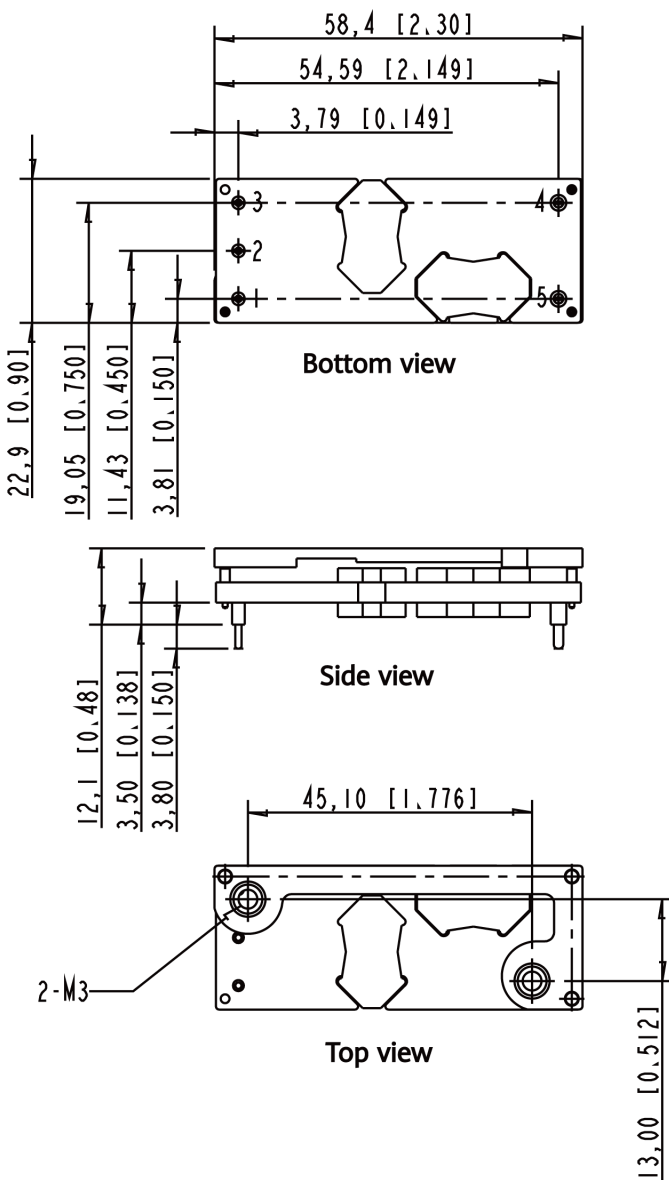

**Table 7-1** Pin description

Pin No.	Pin description
1	V <sub>in</sub> (+)
2	On/Off
3	V <sub>in</sub> (-)
4	V <sub>out</sub> (-)
5	V <sub>out</sub> (+)

#### NOTE

1. All dimensions in mm [in.].  
Tolerances: x.x ± 0.5 mm [x.xx ± 0.02 in.]; x.xx ± 0.25 mm [x.xxx ± 0.010 in.].
2. Pins 1-3 are 1.00 ± 0.05 mm [0.040 ± 0.002 in.] diameter with 2.00 ± 0.10 mm [0.080 ± 0.004 in.] diameter standoff shoulders. Pin 4 and pin 5 are 1.5 ± 0.05 mm [0.060 ± 0.002 in.] diameter with 2.50 ± 0.10 mm [0.098 ± 0.004 in.] diameter standoff shoulders.
3. M3 screw used to bolt units baseplate to other surfaces (such as heatsink) must not exceed 3.2 mm [0.126 in.] depth below the surface of baseplate.
4. Components will vary between models.

# 8 Safety

## 8.1 Reliability Characteristics

Table 8-1 Reliability characteristics

Parameter	Minimum	Typical	Maximum	Unit	Notes & Conditions
Mean time between failures (MTBF)	-	2.5	-	Million hours	Telcordia SR332 Method 1 Case 3; 80% load  $T_A = 40^\circ\text{C}$ ; normal input/rated output; airflow rate = 1.5 m/s (300 LFM)

## 8.2 EMC Specifications

Figure 8-1 EMC test set-up diagram

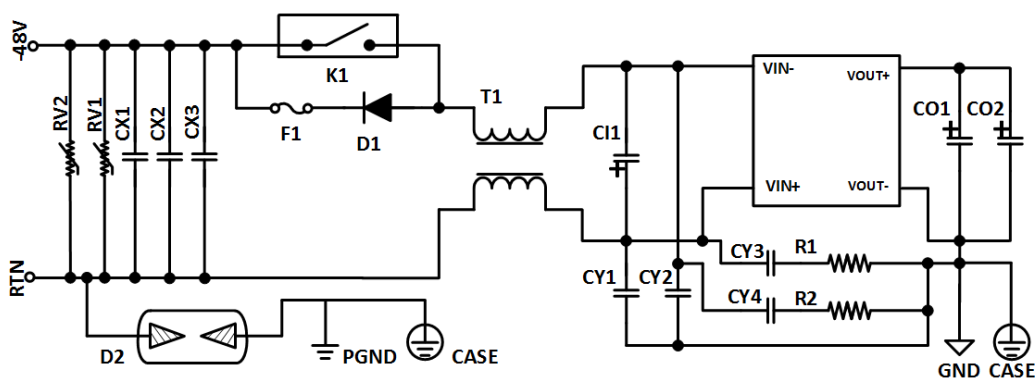

- D1 Schottky diode, 400 V, 16 A
- D2 Gas discharge tube, 90 V, 10 kA
- RV1, RV2 Varistor, 100 V, 4500 A

CX1–CX3	Mentalized film capacitor, 275 V, 1 $\mu$ F
F1	125 V, 3 A fuse (slow blowing)
K1	30 A
T1	EMI common-mode inductor, 400 $\mu$ H
CI1	Aluminum electrolytic capacitor, 100 V, 220 $\mu$ F + 100 $\mu$ F
CY1, CY2	Mentalized film capacitor, 275 V, 0.1 $\mu$ F
CY3, CY4	SMD ceramic capacitor, 1000 V, 22 nF
R1, R2	Chip thick film resistor, 1 W, 1 $\Omega$
CO1, CO2	Aluminum electrolytic capacitor, 100 V, 470 $\mu$ F

**Table 8-2** EMC specifications

Parameter	Conditions	Criterion
Conducted emission (CE)	Class A	EN 55022
Electrostatic discharge (ESD)	Level 3	IEC/EN 61000-4-2, criterion B
Surge	0.6 kV	IEC/EN 61000-4-5, criterion B
DC voltage dips, short interruption, variation	-	EN 61000-4-29, criterion B

### NOTE

1. Except the ESD and DIP test items, other items must be tested together with the system.
2. This is a class A product. In residential areas, this product may cause radio interference. Therefore, users may be required to take appropriate measures.

## 8.3 Recommended Fuse

The converter has no internal fuse. To meet safety requirements, a 20 A fuse is recommended.

## 8.4 Recommended Reverse Polarity Protection Circuit

Reverse polarity protection is recommended under installation and cabling conditions where reverse polarity across the input may occur.

**Figure 8-2** Recommended reverse polarity protection circuit

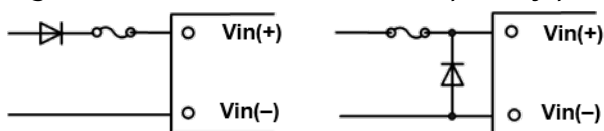

### 8.5 Qualification Testing

Parameter	Units	Condition
Highly accelerated life test (HALT)	6	Low temperature limit: -60°C; high temperature limit: 110°C; vibration limit: 40 G; temperature change rate: 40°C per minute; vibration frequency range: 10-10000 Hz; axes of vibration: X/Y/Z
Thermal humidity bias (THB)	16	Maximum input voltage; 85°C; 85% RH; 1000 operating hours under lowest load power
High temperature operation bias (HTOB)	16	Rated input voltage; ambient temperature between +45°C and +55°C; airflow rate = 0.5-5 m/s, 1000 operating hours; 50% to 80% load
Power and temperature cycling test	32	Rated input voltage; ambient temperature between -40°C and +85°C; airflow rate = 0.5-5 m/s, 1000 operating hours; 50% load

### 8.6 Thermal Consideration

#### Thermal Test Point

Decide proper airflow to be provided by measuring the temperature at the baseplate shown in **Figure 8-3** to protect the converter against overtemperature. The overtemperature protection threshold is obtained based on this thermal test point.

**Figure 8-3** Thermal test point

Thermal test point

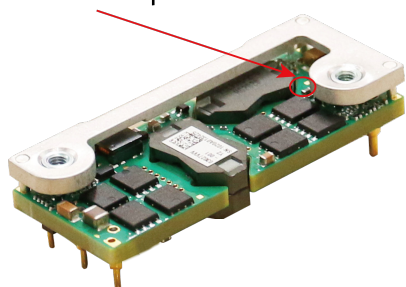

#### Power Dissipation

The converter power dissipation is calculated based on efficiency. The following formula reflects the relationship between the consumed power ( $P_d$ ), efficiency ( $\eta$ ), and output power ( $P_o$ ):  $P_d = P_o (1 - \eta)/\eta$ .



## 8.7 MSL Rating

Store and transport the converter as required by the moisture sensitivity level (MSL) rating 3 specified in the J-STD-020/033. The surface of a soldered converter must be clean and dry. Otherwise, the assembly, test, or even reliability of the converters will be negatively affected.

## 8.8 Mechanical Consideration

### Installation

Although the converter can be mounted in any direction, free airflow must be available.

### Soldering

The converter supports standard wave soldering, reflow soldering and hand soldering.

1. For wave soldering, the converter pins can be soldered at 260°C for less than 7 seconds.
2. For reflow soldering, the converter pins can be soldered at 260°C for less than 10 seconds.
3. For hand soldering, the iron temperature should be maintained at 350°C to 420°C and applied to the converter pins for less than 10 seconds.

The converter can be rinsed using the isopropyl alcohol (IPA) solvent or other suitable solvents.

**Figure 8-4** Recommended reflow profile using lead-free solder

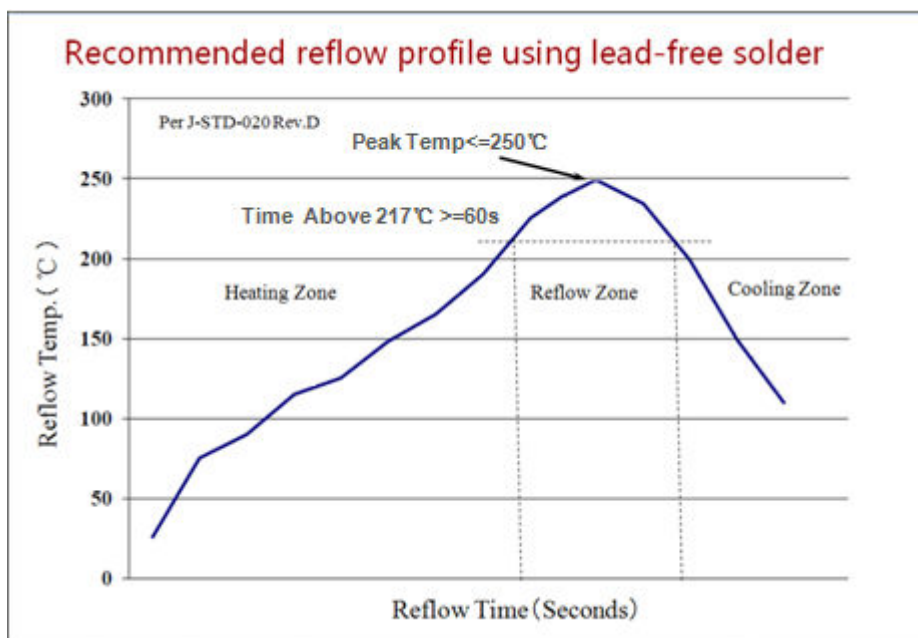



**Copyright © Huawei Technologies Co., Ltd. 2020. All rights reserved.**

No part of this document may be reproduced or transmitted in any form or by any means without prior written consent of Huawei Technologies Co., Ltd.

### **Trademarks and Permissions**



HUAWEI and other Huawei trademarks are trademarks of Huawei Technologies Co., Ltd.

All other trademarks and trade names mentioned in this document are the property of their respective holders.

### **Notice**

The purchased products, services and features are stipulated by the contract made between Huawei and the customer. All or part of the products, services and features described in this document may not be within the purchase scope or the usage scope. Unless otherwise specified in the contract, all statements, information, and recommendations in this document are provided "AS IS" without warranties, guarantees or representations of any kind, either express or implied.

The information in this document is subject to change without notice. Every effort has been made in the preparation of this document to ensure accuracy of the contents, but all statements, information, and recommendations in this document do not constitute a warranty of any kind, express or implied.

**Huawei Technologies Co., Ltd.**

Huawei Industrial Base  
Bantian, Longgang  
Shenzhen 518129  
People's Republic of China

**[www.huawei.com](http://www.huawei.com)**